

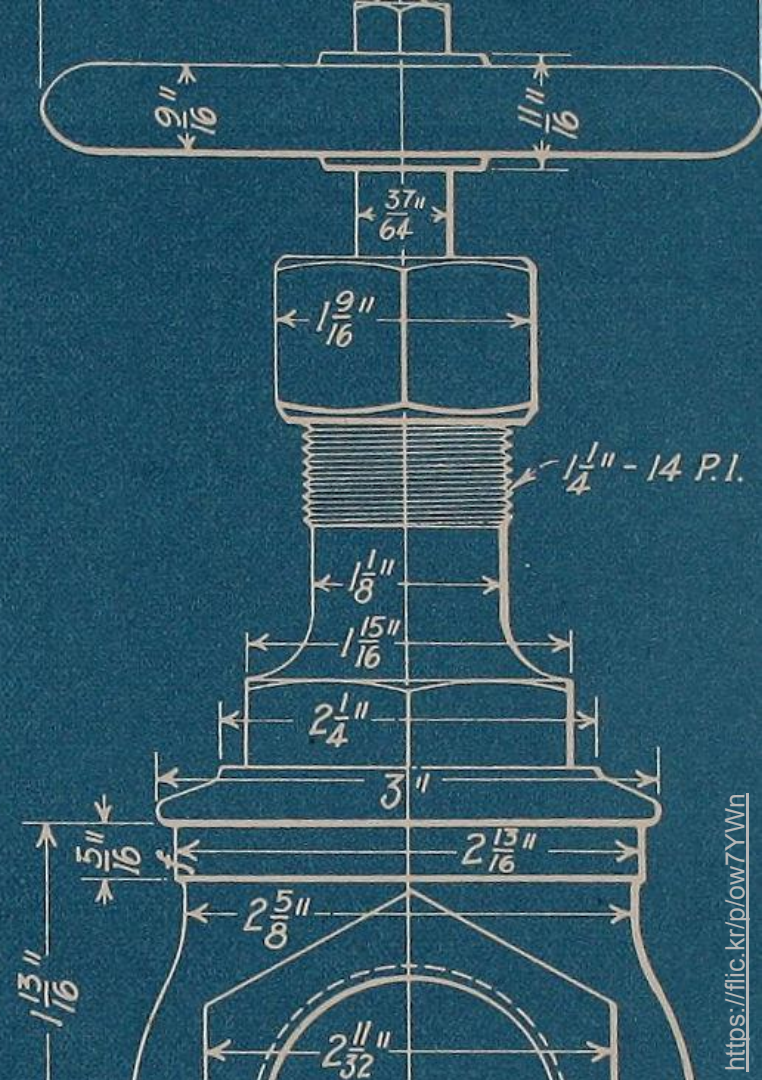

Information technology

trends and the job market



- Εισαγωγή
- Τάσεις στην αγορά εργασίας (40 χρόνια)
- Η εξαίρεση της πληροφορικής
- Πανεπιστήμιο & επόμενα βήματα
- Η 1η μου δουλειά



Adzuna is lending the time to prepare and present this talk

The opinions expressed in this presentation are personal and not necessarily those of Adzuna

vkatsikaros *at* gmail *dot* com

Τα slides θα δοθούν, όλα οι πηγές θα είναι διαθέσιμες

Βάλτε ερωτήσεις στο chat συζητάμε στο τέλος

Άδειες & αναφορές

- Εικόνες: αναφορά ανά εικόνα
- Εικονίδια: <https://github.com/twitter/twemoji>
- Σημείες: Wikipedia articles

Βαγγέλης Κατσικάρος



- Head of infrastructure (20% line mngt, 20% strategic planning, 60% IC)
- Infrastructure engineer
- Backend engineer & DB administrator

- 12 χρόνια remote
- Startup: 2 founders + 3 υπάλληλοι → 100 υπάλληλοι



ValueMyCV
WHAT ARE YOU WORTH?

Upload your CV today

SEARCH JOBS

What?

Where?

Let's restart Britain's jobs engine. [1000's of remote jobs](#) > or [find out more](#) >

Adzuna - zero in on the right role

Every job

Searching for the right job is hard work. We've brought

Smart matches

We've spent a decade developing a more

Great data

Using the best tools is a no brainer. Find local salary

[Sign in](#) [Create account](#) [Employers](#) [Cymraeg](#)

Find a job

Tell us about this service – your feedback will help us to improve it.

What?

Where?

[Advanced search](#)

Apply for jobs

You can search for jobs without an account. But to apply you need to create an account or sign in.

[Create account](#) >

Already have an account? [Sign in](#)

Latest update

JobsAware

To stay safe in your job search and flexible work we recommend that you visit [JobsAware](#) for information and to get free, expert advice for safer work.

Find an apprenticeship

Like the idea of becoming an apprentice? Use [Find an apprenticeship](#) to search, register and apply for apprenticeship vacancies.

Jobseekers from abroad

Before applying for jobs please [check whether you need a visa](#) to work in the UK.

Popular categories

- [Trade and construction jobs](#)
- [Hospitality and catering jobs](#)
- [Maintenance jobs](#)
- [Logistics and warehouse jobs](#)
- [Healthcare and nursing jobs](#)

Popular locations

- [London](#)
- [Glasgow](#)
- [Liverpool](#)
- [Manchester](#)
- [Leeds](#)

Popular searches

- [Cleaner jobs](#)
- [Warehouse jobs](#)
- [Retail jobs](#)
- [Driver jobs](#)
- [Labourer jobs](#)

[Browse all jobs](#) >



What? Where? [Advanced](#)

645 Python sql Jobs in London

Average salary
£61,997

Receive the newest jobs for this search by email:

Filter results	
Sort by	+
Salary	+
Remote	+
Location	+
Category	+
Company	+
Contract type	+
Hours	+

- Related searches**
- [python](#)
 - [python developer](#)
 - [sql](#)
 - [sql analyst](#)

Data Developer Python SQL - WfH

£55000 - £70000 PER ANNUM + BENEFITS - CLIENT SERVER - LONDON, SOUTH EAST, SOUTH EAST LONDON

Data Developer London to £70k Remote Interview WFH Data Developer / Engineer (**Python SQL** BI) Remote Interview WFH. Are you a data technologist seeking a role where you'll ... a competitive salary (to £70k) plus benefits. Apply now or call 020 8016 4456 to find out more about this Data Developer / Engineer (**Python SQL** BI) opportunity. This job was originally posted ...

Data Engineer - Python, SQL, Spark

JOBSWORTH: £ 52,136 P.A. - OLIVER BERNARD - LONDON, SE11

Data Engineer - **Python, SQL**, Spark Location: London, N1C 4AX (Remote currently)Salary: £60,000 - £70,000Industry: E-commerceTech Stack: **Python, SQL**, Pandas, Spark, AWSGreat ... opportunity for a talented Data Engineer (**Python, SQL**, Pandas, AWS) who also has strong experience of developing applications using Python to join a business that is entrusted ...

Python/ SQL Developer

JOBSWORTH: £ 46,837 P.A. - AUSTIN FRASER - LONDON, LONDON

Python/ SQL Developer 3 month contract London/ Remote Austin Fraser are currently partnering with an exciting London-based start up who have some interesting projects coming up ... and are urgently looking for a **Python/ SQL** Developer to join them. This will be a 3 month contract initially with strong possibilities of multiple extensions beyond this. It will be fully remote ...

Adzuna με νούμερα

- TLDs: 16
- Traffic: ☆☆M visits/month
- Machines: ☆☆☆
- Web scraper: ☆M ads/day
- User facing DB: ☆TB storage
- Sent: ☆M emails/day

- In 2020, we estimate we have helped 0.5M people find jobs 🎉

A woman with dark hair, wearing a white patterned shirt and brown leather gloves, is focused on working with a bundle of copper wires. She is using a red-handled tool, possibly a wire cutter or pliers, to work on the wires. The background is dark, and there are several large coils of copper wire visible. The overall scene suggests a technical or industrial setting.

Η αγορά εργασίας

Οι συνθήκες στην αγορά εργασίας

δεν είναι ιδανικές





“Η κρίση έχει προκαλέσει έκρηξη αβεβαιότητας και ανασφάλειας και σοβαρή έλλειψη εμπιστοσύνης των εργαζομένων όσον αφορά την προστασία θεμελιωδών εργασιακών δικαιωμάτων τους και του βιοτικού τους επιπέδου”

https://www.inegsee.gr/wp-content/uploads/2020/10/Ethsia_Ekthesi_2020_INEGSEE.pdf “Η ελληνική οικονομία και η απασχόληση - Ετήσια Έκθεση, Ινστιτούτο Εργασίας ΓΣΕΕ”, 2020



“Το β’ τρίμηνο του 2020 ο μέσος μηνιαίος μισθός μειώθηκε κατά περίπου 10% σε σχέση με το ίδιο τρίμηνο του 2019. Στο ίδιο διάστημα το ποσοστό των απασχολούμενων που λάμβανε από 0 έως 200 ευρώ αυξήθηκε από 1% σε περίπου 12%”

βλ. προηγούμενη πηγή



“Salaries were adjusted, but the increased competition that should have helped to bring prices down never happened. The burden of the internal devaluation fell excessively on labor.”

<https://www.imf.org/en/News/Articles/2019/10/01/sp093019-The-IMF-and-the-Greek-Crisis-Myths-and-Realities> “The IMF and the Greek Crisis: Myths and Realities”, IMF, 2019



“Several years of recession and austerity measures have persistently challenged the constitutionally protected right to work and the right to an adequate standard of living.”

“Salaries were drastically cut [...] and working conditions weakened”

<https://pace.coe.int/en/files/24264/html> “The progress of the Assembly's monitoring procedure”, Council of Europe, 2017



1992-2016: “While real annual wages grew by a total of 20% in the top decile, they did not change in the fifth and sixth deciles, and in the two lowest deciles they decreased by around 35%”

https://www.diw.de/documents/publikationen/73/diw_01.c.579137.de/dwr-18-09-1.pdf “Inequality in Germany: decrease in gap for gross hourly wages since 2014, but monthly and annual wages remain on plateau”, DIW, 2018



“1 in every 8 children in America (σημ ΗΠΑ) is experiencing shockingly high rates of food insecurity, school drop out, teenage pregnancy and/or child deaths”

<https://www.savethechildren.org/content/dam/usa/reports/advocacy/us-childhood-report-2020.pdf> “The Land of Inopportunity”, Save the Children, 2020



“Real wages rose at the top of the distribution, whereas wages stagnated or fell at the middle and bottom.”

<https://crsreports.congress.gov/product/pdf/R/R45090/13> “Real Wage Trends, 1979 to 2018”, US Congressional Research Service, 2018





Η πληροφορική

είναι από τις εξαιρέσεις

Έλλειψη προσωπικού

“One in 5 enterprises employed ICT specialists”

“In 2017, more than half of EU enterprises that recruited or tried to recruit ICT specialists had difficulties in filling ICT vacancies.”

* ICT (Information and Communication Technology)

[https://ec.europa.eu/eurostat/statistics-explained/index.php?title=ICT specialists - statistics on hard-to-fill vacancies in enterprises#Employment and recruitment of ICT specialists](https://ec.europa.eu/eurostat/statistics-explained/index.php?title=ICT_specialists_-_statistics_on_hard-to-fill_vacancies_in_enterprises#Employment_and_recruitment_of_ICT_specialists) “ICT specialists - statistics on hard-to-fill vacancies in enterprises”, Eurostat, 2018

Έλλειψη προσωπικού

2015: “Europe could face a shortage of more than 800,000 skilled ICT workers by 2020”

https://ec.europa.eu/commission/presscorner/detail/en/speech_15_4770 “Turning Europe digital, preparing for future growth”, Andrus Ansip - Executive Vice President of the European Commission for A Europe Fit for the Digital Age, 2015

2017: “shortages of IT specialists are forecasted to reach around 500,000 by 2020 and we estimate that Europe would need 50,000 new high-tech leaders each year till 2025”.

http://eskills-scale.eu/fileadmin/eskills_scale/all_final_deliverables/scale_e-leadership_agenda_final.pdf “High-Tech Leadership Skills for Europe”, European Commission, 2017

Μισθός - UK

london, uk

backend developer

graduate degree (e.g. ma, ms)

postgresql

amazon-web-services

linux

go

python

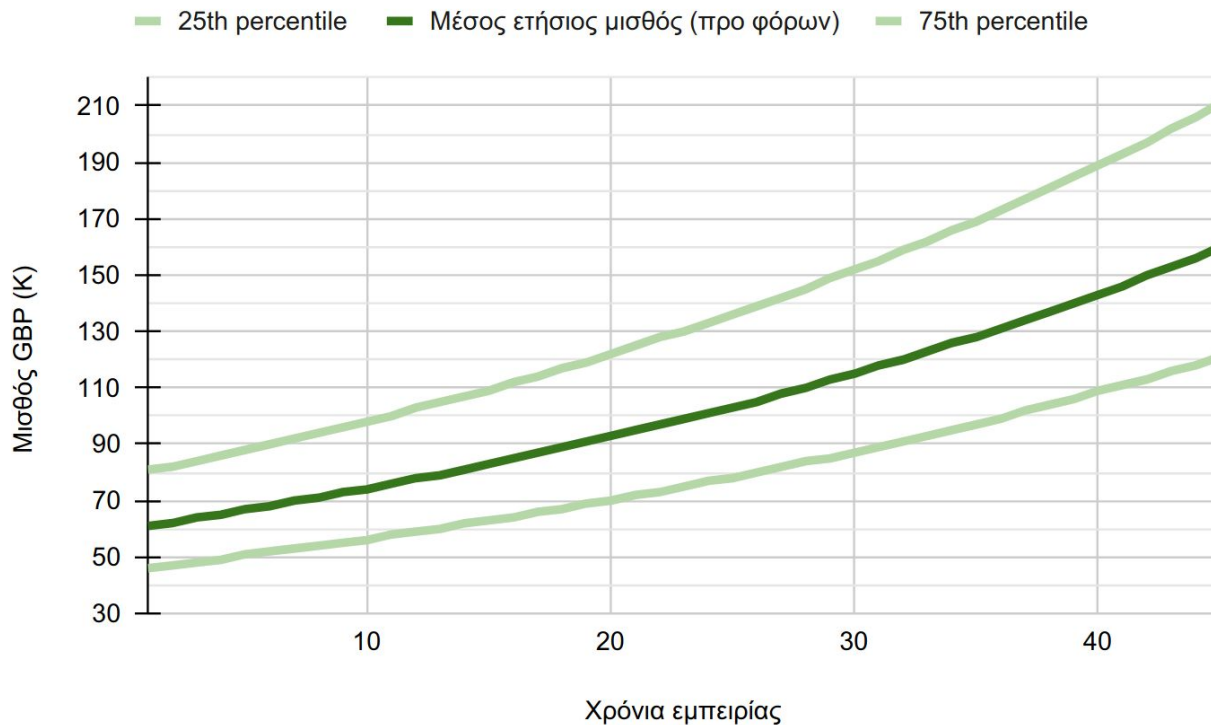

Μισθός - UK

london, uk

backend developer

graduate degree (e.g. ma, ms)

postgresql

amazon-web-services

linux

go

python

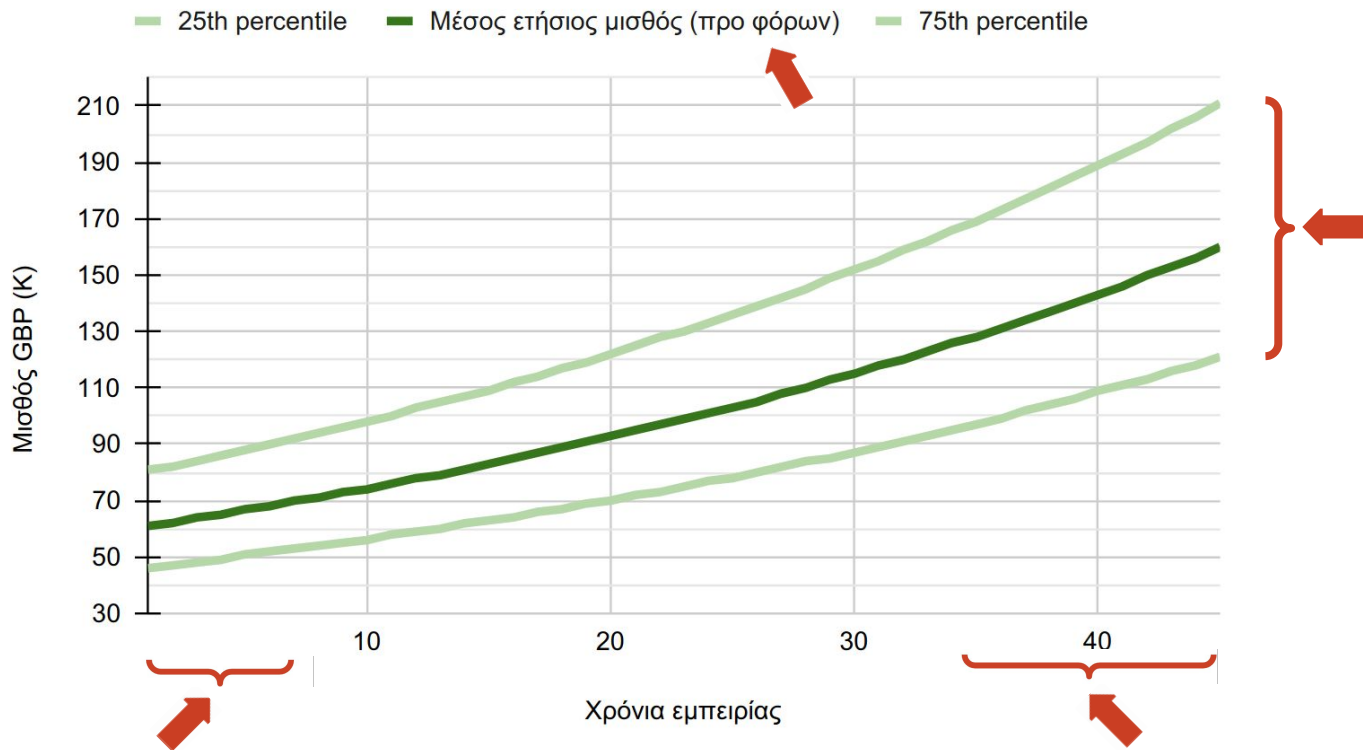

Μισθός - UK vs US

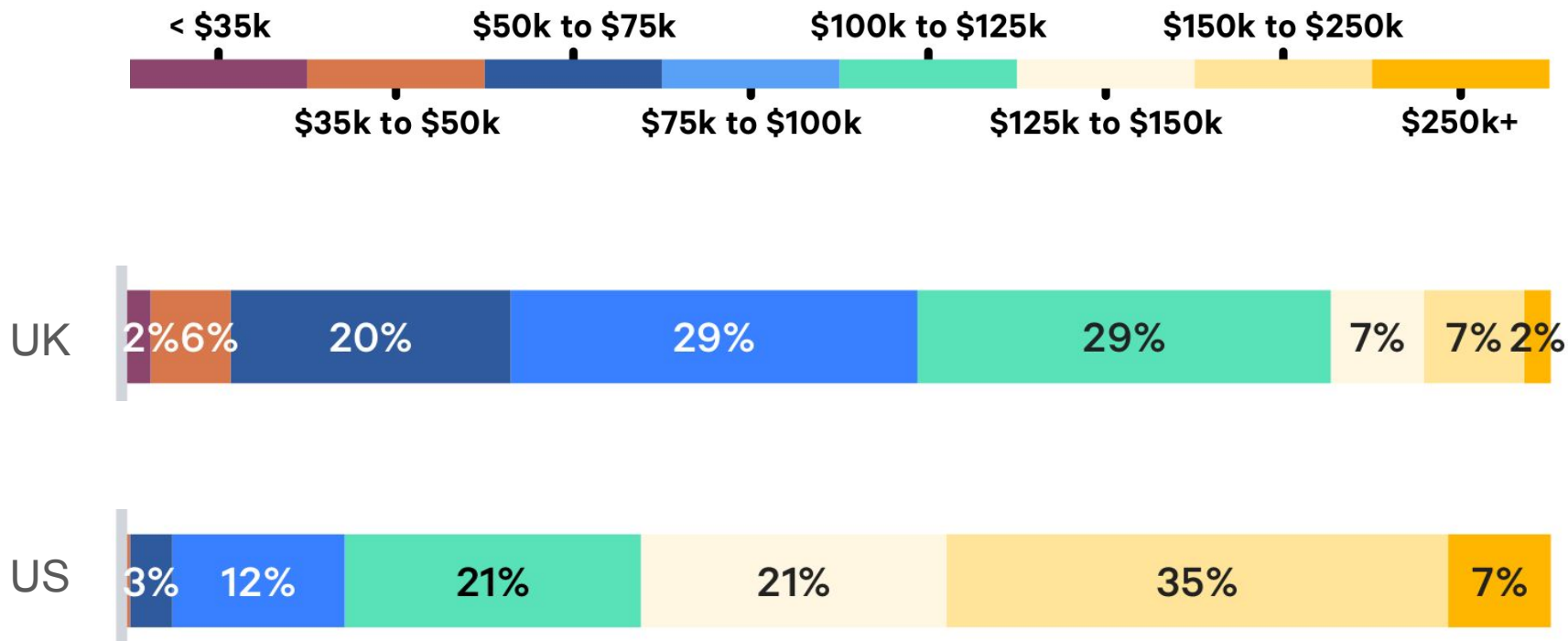

Top-tier

“Basecamp pays in the top 10% of the industry based on San Francisco rates. Same position, same pay, no matter where you live. The salary for this position is \$134,257 (for Systems Admin) or \$167,962 (for Senior Systems Admin)”.

<https://m.signalvnoise.com/basecamps-ops-team-is-hiring/> “Basecamp’s Ops Team is Hiring”, Basecamp, 2020

“salaries in our privileged domain have gotten much higher than our \$175,000 (and indeed, many at Oxide have taken a cut in pay to work here)”.

<https://oxide.computer/blog/compensation-as-a-reflection-of-values/> “Compensation as a Reflection of Values”, Oxide Computer, 2021

Πού βρίσκομαι;

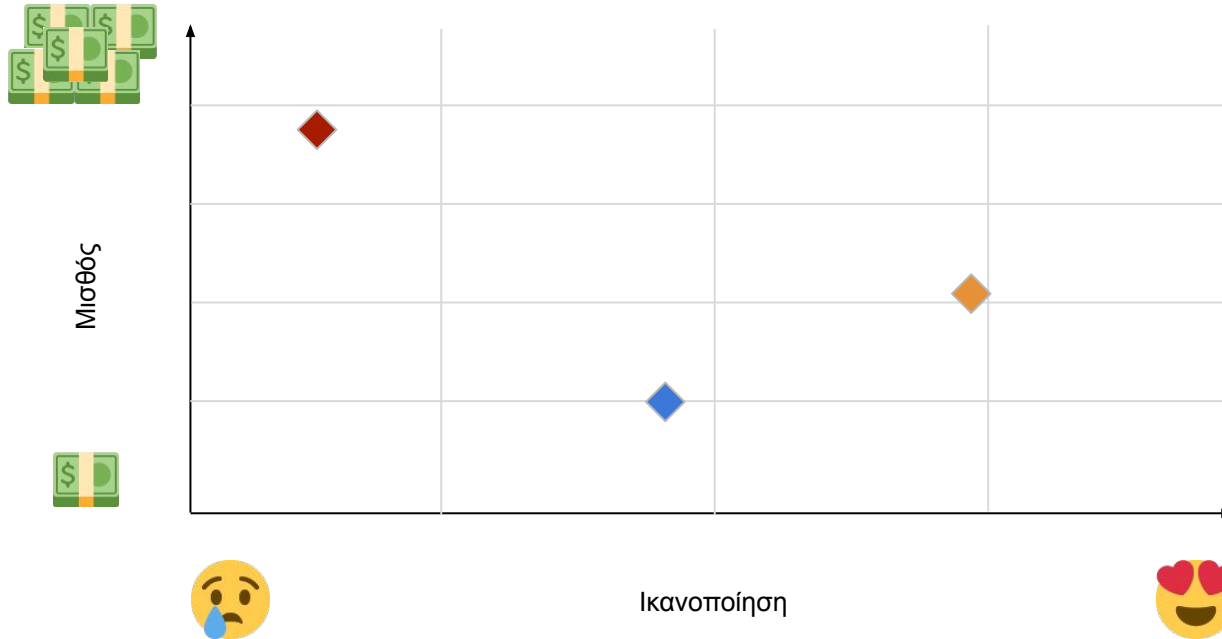

Remote work

Χρήσιμα

- Πειθαρχία
- Εμπειρία από γραφείο
- Οξυμένες επικοινωνιακές δεξιότητες

Να έχετε κατά νου

- Έλλειψη κοινωνικής επαφής
- Κρυφά κόστη (γραφείο, +1 δωμάτιο, θέρμανση)
- Ωράριο

Το σκάσιμο της νεραϊδόφουσας



αυτοματισμός

<https://flic.kr/p/asNpjj>



κορεσμός

<https://flic.kr/p/jUXr6>



οικονομικές κρίσεις

<https://flic.kr/p/c68WbW>

A photograph of a library interior. In the foreground, a wooden staircase with a metal railing leads up. The background is filled with tall wooden bookshelves packed with books of various colors. A red fire extinguisher is visible on the wall behind the staircase.

Πανεπιστήμιο

και επόμενα βήματα

Red brick & Ivy league



mit tuition fees

All



Images



News



Maps



Videos



More

Settings

Tools

About 11,000,000 results (0.65 seconds)

Massachusetts Institute of Technology / Undergraduate tuition and fees

53,790 USD

2019 – 20

People also search for



Harvard University
51,925 USD



Stanford University
53,529 USD



Yale University
55,500 USD

Sources include: IPEDS

Feedback

ShanghaiRanking's Global Ranking of Academic Subjects 2020 - Computer Science & Engineering

Field:	Engineering	Subject:	Computer Science & Engineering
World Rank	Institution*	Country/Region	National/Regional Rank
1	Massachusetts Institute of Technology (MIT)		1
2	Stanford University		2
3	University of California, Berkeley		3
4	Carnegie Mellon University		4
5	ETH Zurich		1
6	Harvard University		5
7	Tsinghua University		1
8	Nanyang Technological University		1
9	University of Toronto		1
10	University of Oxford		1
11	University of California, Los Angeles		6
12	Princeton University		7
13	University of Technology Sydney		1
14	Cornell University		8
15	University of Southern California		9
16	The University of Texas at Austin		10
17	University of North Carolina at Chapel Hill		11
18	National University of Singapore		2
19	Shanghai Jiao Tong University		2
20	Zhejiang University		3
21	Harbin Institute of Technology		4
22	The Chinese University of Hong Kong		1
23	University College London		2
24	Peking University		5
25	University of Science and Technology of China		6

MSc + δίδακτρα

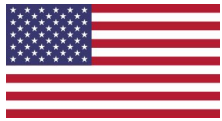

MSc + κόστος ζωής

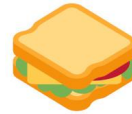

Ενδεικτικά:

<https://www.numbeo.com/cost-of-living/>, “Numbeo is the world’s largest cost of living database”

<https://www.mylifeelsewhere.com/cost-of-living/compare-cities>, “Compare countries and cities around the world”

Προγραμματισμός

Εκτεθείτε στον προγραμματισμό, η γλώσσα δεν έχει τόσο μεγάλη σημασία



bash



JavaScript

Βασικές τεχνικές δεξιότητες

Network (TCP, HTTP)

SQL

Linux cli

Computer architecture

<https://wizzardzines.com/>, “programming zines”, Julia Evans

<https://training.linuxfoundation.org/training/introduction-to-linux/>, “Introduction to Linux (LFS101x)”, The Linux Foundation
[Ops School Curriculum — Ops School Curriculum 0.1 documentation](#) “Ops School Curriculum”

Open source projects / Google Summer of Code

Ανοίξτε τους ορίζοντές σας, εκτεθείτε σε συνεργασίες

1. Βρείτε οργανισμούς / project που σας ενδιαφέρουν
2. Δοκιμάστε
 - Ετοιμάστε το dev περιβάλλον σας
 - Επικοινωνήστε με τους developers / κοινότητα (slack/ mailing list)
 - Βρείτε 1-2 απλά bugs
 - Δοκιμάστε (commits)

<https://python-gsoc.org/index.html#gettingstarted> “Python Summer of Code - How do I get started?”

http://blog.gerv.net/2006/05/how_not_to_apply_for_summer_of/ “How Not To Apply For Summer Of Code”

<http://www.catb.org/~esr/faqs/smart-questions.html> “How To Ask Questions The Smart Way”

Ξένες γλώσσες, επικοινωνία + soft skills



“This study identified the top 10 soft skills as perceived the most important by business executives: integrity, communication, courtesy, responsibility, social skills, positive attitude, professionalism, flexibility, teamwork, and work ethic.”

<https://journals.sagepub.com/doi/abs/10.1177/1080569912460400> “Executive Perceptions of the Top 10 Soft Skills Needed in Today’s Workplace”

Η πρώτη μου δουλειά



Requirements

“Required Technical and Professional Expertise:



Minimum 12+ years’ experience in Kubernetes administration and management.

Hands-on experience on setting up Kubernetes platform, deploying microservices and other web applications [...]”

https://www.theregister.com/2020/07/13/ibm_kubernetes_experience_job_ad/ “IBM job ad calls for 12 years’ experience with Kubernetes – which is six years old” Simon Sharwood

Requirements

Δεν χρειάζεται να πληροίτε το 100% των προαπαιτούμενων

“2+ χρόνια προϋπηρεσία” αγνοήστε το - ειδικά αν έχετε commits, internship, GSOC

Φορολογικά + Ασφαλιστικά

Μάθετε πόσα λεφτά θα μείνουν στην τσέπη σας.

Ενημερωθείτε για τις διαφορές μισθωτού / ελεύθερου επαγγελματία.

Αν βρείτε εργοδότη στο εξωτερικό μάθετε για το καθεστώς του ΦΠΑ.

Η αίτηση σας και θα αγνοηθεί και θα απορριφθεί 🤪

Αποστολή



Απάντηση



Τελική
προσφορά



Στόχοι για την 1η δουλειά

Είναι OK να μην βρείτε τον σούπερ μισθό με την πρώτη. **Θα συμβεί!**

Για αρχή ψάξτε για ένα υγιές περιβάλλον που μπορείτε να μάθετε.

Επόμενα βήματα

Ζητήστε εκπαιδευτικό υλικό (βιβλία, μαθήματα, video, και φυσικά χρόνο).

Ζητήστε να δουλέψετε με senior μέλος της ομάδας.

Ψάξτε για την επόμενη δουλειά αν κάτι δεν σας ικανοποιεί.

Εξασκηθείτε στις συνεντεύξεις και να γνωρίζετε τι παίζει στην αγορά.

Την μεγαλύτερη αύξηση θα την πάρετε αλλάζοντας δουλειά.

Κάντε την έρευνά σας

Job boards

- <https://www.adzuna.co.uk/> (.com, .fr, .it, κτλ)
- <https://gr.indeed.com> (.co.uk, .fr, .it, κτλ)
- <https://www.glassdoor.com>
- <https://stackoverflow.com/jobs/>

Remote work

- <https://github.com/fossjobs/fossjobs/wiki/resources#job-aggregators>
- <https://weworkremotely.com/>
- <https://remoteintech.company/>

Απευθείας στα site των εταιρειών που σας ενδιαφέρουν



- Ο χώρος της πληροφορικής είναι μισθολογικά προνομιακός
- Αναλογιστείτε την καριέρα σας τακτικά και για διαφορετικές χρονικές κλίμακες
- Το ελληνικό πανεπιστήμιο ένα καλό βήμα από τα πολλά που θα κάνετε
- Ανοίξτε τους ορίζοντές σας, ασχοληθείτε με open source projects
- Ψαχτείτε, κάντε συνεντεύξεις, μάθετε τι παίζει στην αγορά
- Αναζητήστε ένα υγιές περιβάλλον που μπορείτε να μάθετε

Ερωτήσεις;

